

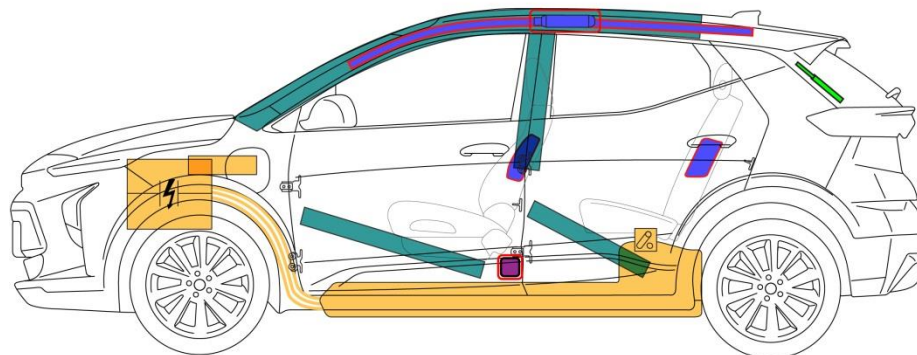

**Chevrolet  
Bolt EUV  
2022-2023**

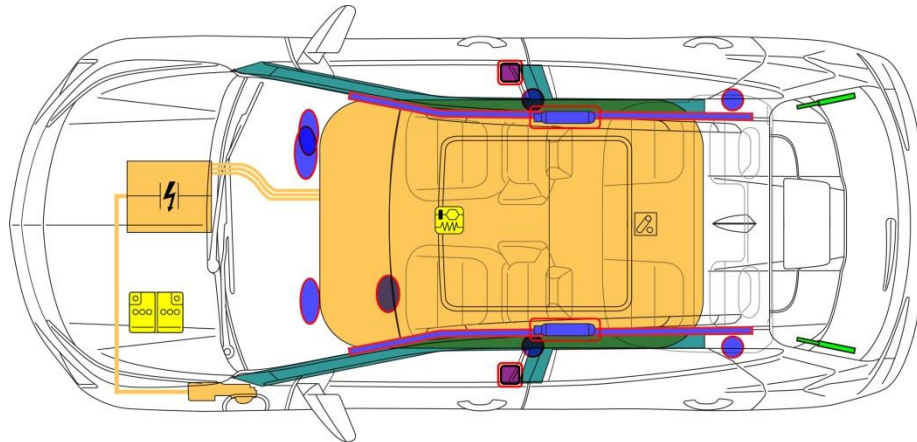

	Airbag		Gerador de gás		Tensores do cinto de segurança		BA de controle do SRS		Sistema de proteção de pedestres ativo
	Sistema de proteção automático contra capotagem		Amortecedor a gás/ mola pré-carregada		Reforço de Estrutura		Zona que requer atenção especial		
	Baixa tensão da bateria		Ultracapacitor, baixa tensão		Tanque de combustível		Tanque de gás		Válvula de segurança
	Bateria de alta tensão		Componente do cabo de alimentação de alta tensão		Desconexão da alta tensão		Sistema de alta tensão de desativação da caixa de fusíveis		Ultracapacitor, alta tensão

	Número de identificação	Número da versão	Número da página
	1G1-21202	3	1

## 1. Identificação/reconhecimento



Ausência de ruído do motor não significa que o veículo esteja desligado: existe capacidade de movimento do veículo até que ele seja totalmente desligado. Usar sempre o EPI apropriado.

### Placa de identificação



O BOLT EUV pode ser identificado pelos emblemas que aparecem no aplique superior do para-lama dianteiro e na tampa do porta-malas do veículo.

### Etiqueta de informações de primeiros socorros

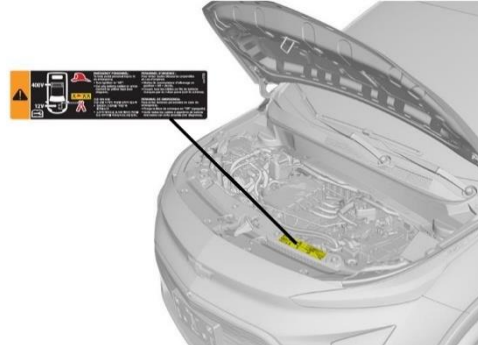

## 2. Imobilização/estabilização/levantamento

### IMOBILIZAR O VEÍCULO:

1. Bloquear as rodas.
2. Puxe o interruptor do freio de estacionamento eletrônico (EPB).
3. Pressione o botão P (Estacionamento).

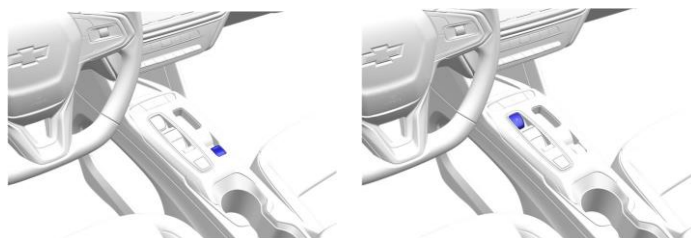

### PONTOS DE LEVANTAMENTO:



indica os locais principais de levantamento.

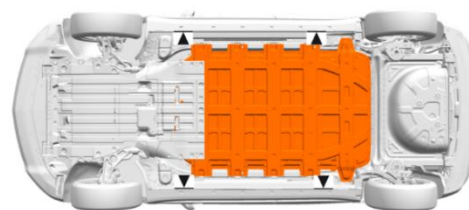

## 3. Desativar perigos diretos/normas de segurança

### MÉTODO PRINCIPAL:

1. Pressionar o botão POWER (botão de partida) para desativar a propulsão do veículo.
2. Remover as chaves do veículo.
3. Abra o capô.
4. Cortar duas vezes o cabo de baixa tensão marcado pela fita amarela.

NÃO cortar nenhum cabo de alta tensão de cor laranja.



Após desativar a energia de 12 V, aguardar pelo menos 10 segundos para permitir a dissipação de energia de reserva de algum airbag não acionado e aguardar 1 minuto para permitir a descarga da energia de alta tensão.

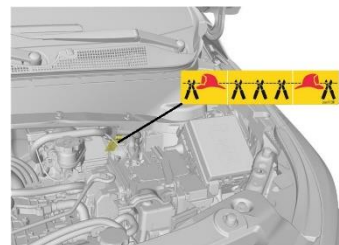

## VEÍCULO NA ESTAÇÃO DE CARREGAMENTO:

Se possível, interromper o carregamento removendo a alça de carregamento do veículo. Se ativado, o alarme antifurto do veículo pode ser acionado.

Alça de carregamento de nível 2 exibida; a alça de nível 3 (carregamento rápido CC) é moderadamente maior e pode exigir mais esforço para ser desconectada.

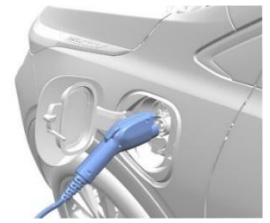

## 4. Acesso aos ocupantes

Consultar a primeira página para obter ilustrações de reforço de estrutura e locais específicos de componentes relacionados à segurança.

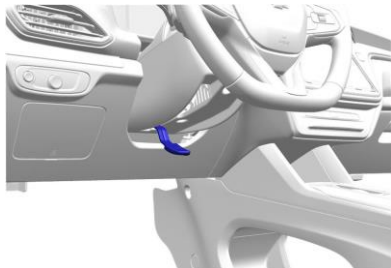

Ajuste da coluna de direção

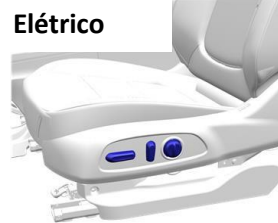

Elétrico

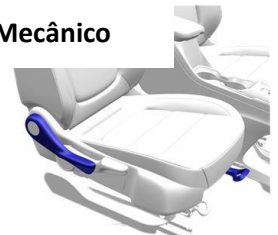

Mecânico

Ajuste do banco

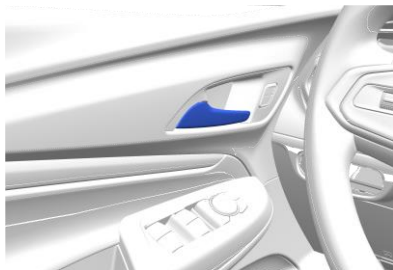

### Abertura de porta trancada

Se as portas permanecerem trancadas, puxe **duas vezes** a alça do lado de dentro da porta para dar acesso ao ocupante em cada local de assento.

 - O vidro do teto e para-brisa é feito de vidro laminado

 - Os vidros das portas laterais e o vidro da tampa do porta-malas são fabricados em vidro temperado



## 5. Energia/líquidos/gases/sólidos armazenados

Li-ion



O vazamento do líquido de arrefecimento dentro da bateria pode se tornar instável e representar possível risco de incêndio. Verificar a temperatura da bateria usando uma câmera de imagem térmica.

## 6. Em caso de incêndio



Potencial de reignição da bateria.



Uma bateria em chamas não explodirá.



Usar quantidades abundantes de água para resfriar a bateria e apagar o fogo.

## 7. Em caso de submersão

Todos os componentes de alta tensão e o compartimento da bateria de alta tensão são conectados ao terra do chassi do veículo. Se o veículo ficar submerso em água, você não será eletrocutado(a) ao tocar nele.

## 8. Reboque/transporte/armazenamento



Gancho dianteiro



Gancho traseiro

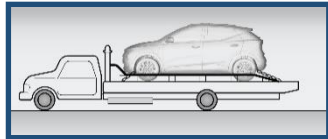

O reboque de plataforma é a melhor maneira de transportar o veículo.

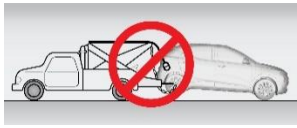
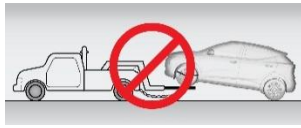
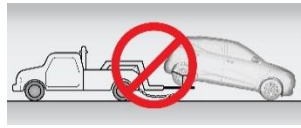

## 9. Informações adicionais importantes

Este veículo é compatível com OnStar, quando disponível.

## 10. Explicação dos pictogramas utilizados

	Veículo elétrico		Inflamável
	Sinal de advertência geral		Tóxico
	Advertência, eletricidade		Corrosivo
	Tecnologia da bateria		Risco de lesão
	Pontos de levantamento		Usar água
	Câmera de imagem térmica		



**Chevrolet  
Bolt EUV  
2022-2023**

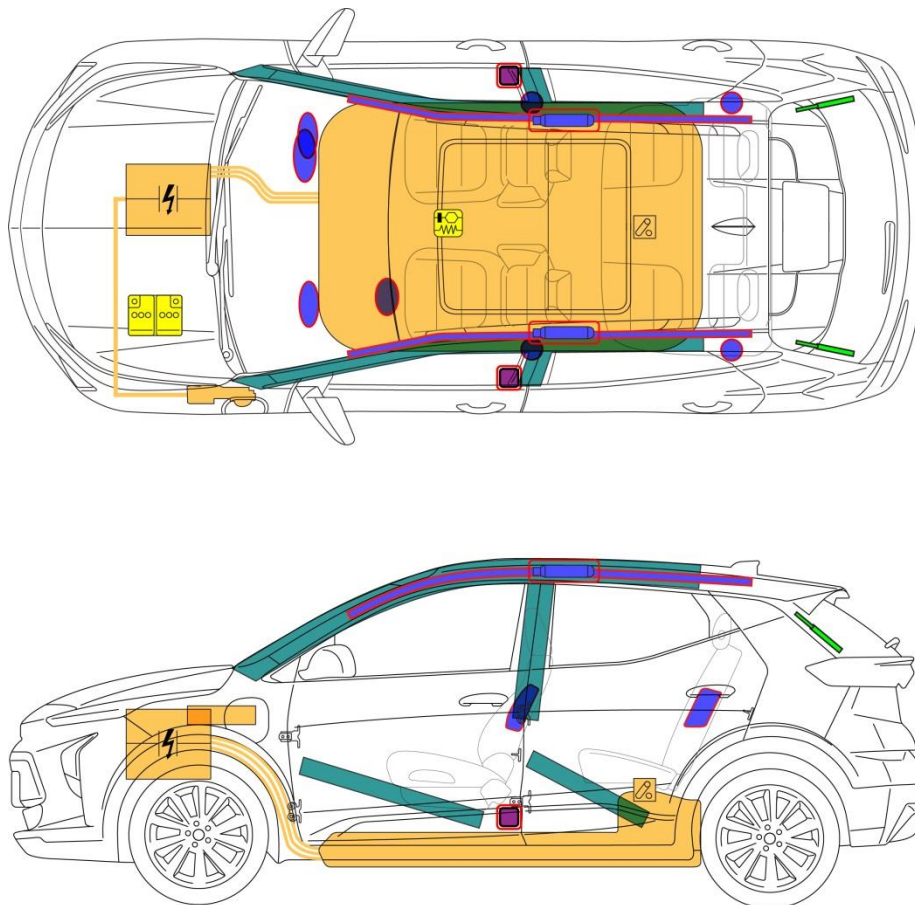

	Airbag		Generador de gas		Pretensor del cinturón de seguridad		Unidad de control del SRS		Protección para peatones activa
	Protección antivuelco automática		Puntal neumático/Resorte precargado		Área de alta resistencia		Área que requiere especial atención		
	Batería de baja tensión		Ultra capacitor, baja tensión		Tanque de combustible		Tanque de gas		Válvula de seguridad
	Batería de alta tensión		Componente de cable de alimentación de alta tensión		Desconexión de alta tensión		Caja de fusibles para cortar la alta tensión		Ultra capacitor, alta tensión

Número de identificación	Número de versión	Número de página
1G1-21202	3	1

## 1. Identificación / reconocimiento



La falta de ruido del motor no significa que el vehículo está desactivado: la capacidad de movimiento del vehículo existe hasta que el mismo esté completamente apagado. Vista siempre equipos de protección apropiados

### Placa de nombre



El BOLT EUV se puede identificar por los emblemas que aparecen en el aplique superior del guardabarros delantero y el portón trasero del vehículo.

### Etiqueta de información para primeros respondedores

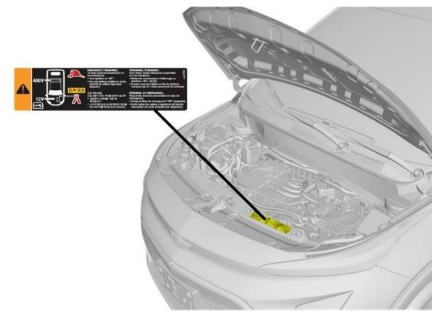

## 2. Inmovilización / estabilización / levantamiento

### INMOVILICE EL VEHÍCULO:

1. Bloquee las ruedas.
2. Tire del interruptor del freno de estacionamiento eléctrico (EPB).
3. Pulse el botón P (Estacionamiento).



### PUNTOS DE LEVANTAMIENTO:

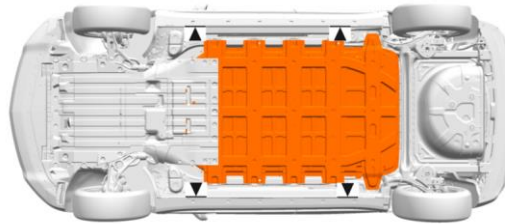

Indica los puntos de levantamiento primarios.

## 3. Protección contra peligros directos / regulaciones de seguridad

### MÉTODO PRINCIPAL:

1. Pulse el botón POWER para desactivar la propulsión del vehículo.
2. Retire las llaves del vehículo.
3. Abra el capó.
4. Efectúe un corte doble del cable de baja tensión marcado con la cinta amarilla.

NO corte ningún cable de alta tensión de color anaranjado.



Después de desactivar la energía de 12 voltios, espere como mínimo 10 segundos para permitir que se disipe cualquier energía de reserva de los airbags sin desplegar y espere por lo menos 1 minuto para permitir que se descargue la energía de alta tensión.

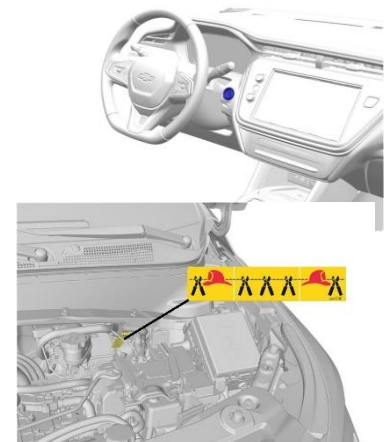

## VEHÍCULO EN LA ESTACIÓN DE CARGA:

Si es posible, termine la carga retirando el mango de carga del vehículo. Si está habilitada, puede activarse la alarma antirrobo del vehículo.

Se muestra el mango de carga de nivel 2. El mango de nivel 3 (carga rápida de CC) es moderadamente más grande y puede requerir un esfuerzo adicional para desconectarlo.

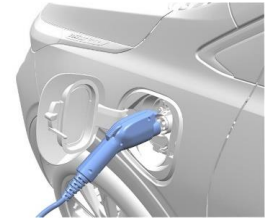

## 4. Acceso de los ocupantes

Consulte en la página inicial las ilustraciones de las zonas de alta resistencia y las ubicaciones de los componentes específicos relacionados con la seguridad.

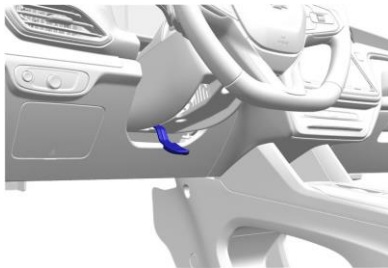

Ajuste de la columna de dirección

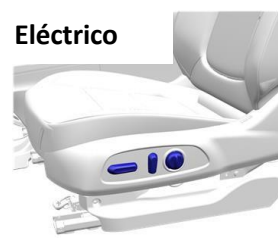

Eléctrico



Mecánico

Ajuste del asiento

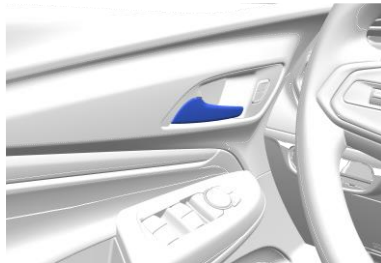

### Apertura de una puerta bloqueada

Si las puertas permanecen bloqueadas, tire **dos veces** de la manija interior de la puerta para acceder al ocupante de cada ubicación de asiento.

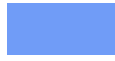
-  - El parabrisa y el techo de cristal son de cristal laminado
-  - Las ventanillas laterales y la luneta del portón trasero son de cristal templado



## 5. Energía almacenada / líquidos / gases / sólidos

Li-ion



El refrigerante que se infiltra dentro del conjunto de batería puede volverse inestable y posiblemente sea un riesgo de incendio. Compruebe la temperatura del conjunto de batería con una cámara de imagen térmica.

## 6. En caso de incendio



Potencial de reignición de la batería



Una batería que se incendia no explotará.



Utilice cantidades abundantes de agua para enfriar la batería a fin de apagar el incendio.

## 7. En caso de inmersión

Todos los componentes de alta tensión y la envuelta de la batería de alta tensión están conectados a la masa del chasis del vehículo. Si el vehículo se sumerge en agua, usted no se electrocutará si lo toca.

## 8. Remolque / transporte / guardado



Gancho delantero

Gancho trasero

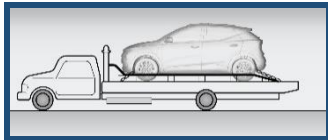

Un transportador de plataforma plana es la mejor manera de transportar el vehículo.



## 9. Información adicional importante

Este vehículo es compatible con OnStar, donde está disponible.

## 10. Explicación de los pictogramas utilizados

	Vehículo eléctrico		Inflamable
	Señal de advertencia general		Tóxico
	Advertencia de electricidad		Corrosivo
	Tecnología de la batería		Riesgo de lesiones
	Puntos de levantamiento		Utilizar agua
	Cámara de imagen térmica		





**Chevrolet  
Bolt EUV  
2022-2023**

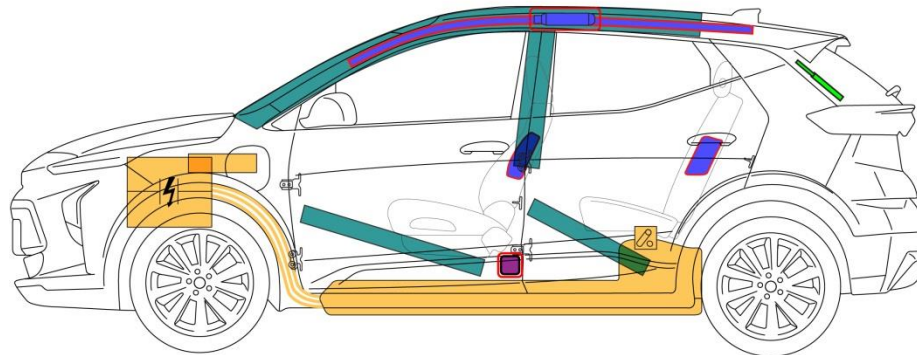
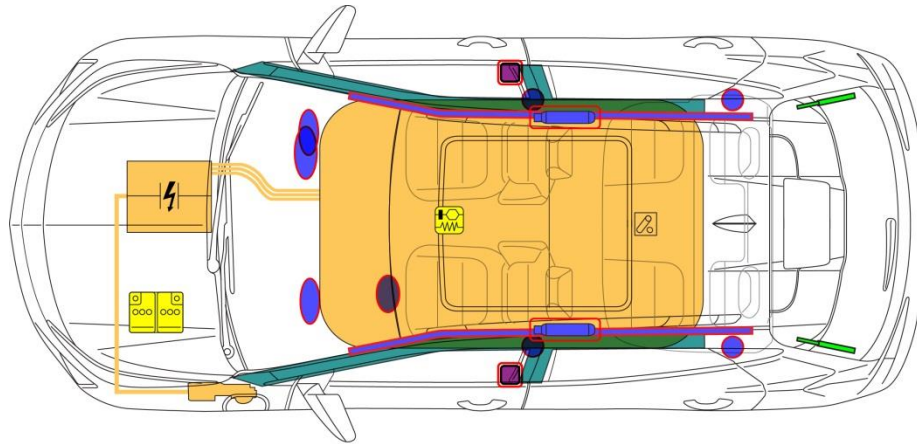

	Airbag		Stored gas inflator		Seat belt pretensioner		SRS control unit		Pedestrian protection active system
	Automatic rollover protection system		Gas strut/Preloaded spring		High strength zone		Zone requiring special attention		
	Battery low voltage		Ultra capacitor, low voltage		Fuel tank		Gas tank		Safety valve
	High voltage battery pack		High voltage power cable component		High voltage disconnect		Fuse box disabling high voltage system		Ultra capacitor, high voltage

Identification Number	Version Number	Page Number
1G1-21202	3	1

## 1. Identification / recognition



Lack of engine noise does not mean vehicle is off: vehicle movement capability exists until vehicle is fully shut down. Always wear appropriate PPE.

### Nameplate



The BOLT EUV can be identified by those emblems that appear on the front fender upper applique and the liftgate of the vehicle.

### First Responder Information Label

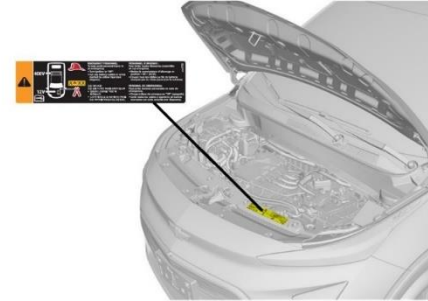

## 2. Immobilization / stabilization / lifting

### IMMOBILIZE VEHICLE:

1. Block the wheels.
2. Pull the Electric Parking Brake (EPB) switch.
3. Press the P (Park) button.

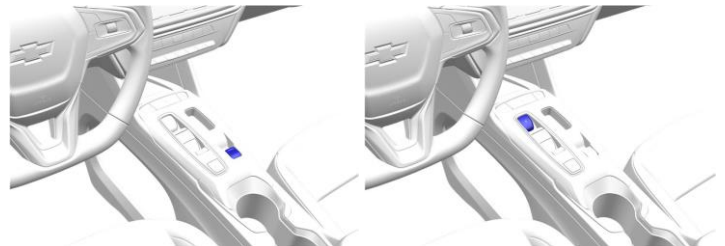

### LIFTING POINTS:

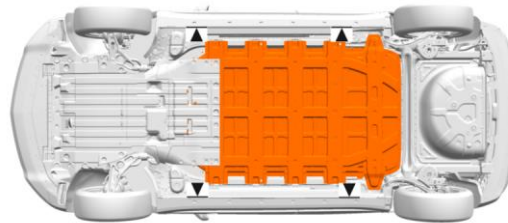

Indicates primary lifting locations.

## 3. Disable direct hazards / safety regulations

### MAIN METHOD:

1. Press the POWER button to disable vehicle propulsion.
2. Remove the keys from the vehicle.
3. Open the hood.
4. Double cut the low voltage cable marked by the yellow tape.

Do NOT cut any orange colored high voltage cables.



After disabling 12-volt power, wait at least 10 seconds to allow any un-deployed airbag reserve energy to dissipate and wait at least 1 minute to allow high voltage energy to discharge.

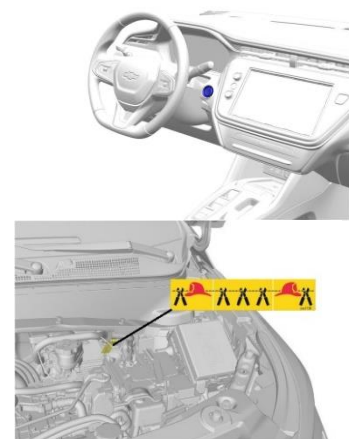

## VEHICLE AT CHARGE STATION:

If able, terminate charging by removing the charge handle from the vehicle. If enabled, the vehicle's anti-theft alarm may activate.

The common charge handle is shown; The DC Fast Charge handle is moderately larger and may require additional effort to disconnect.



## 4. Access to the occupants

Refer to the front page for illustrations high strength zones and specific safety related component locations.

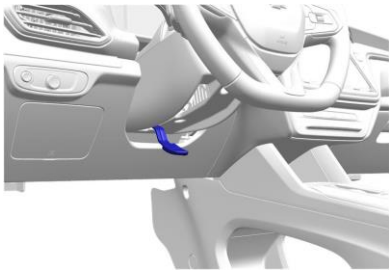

Steering Column Adjustment

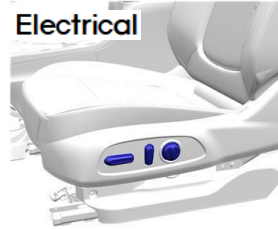

Electrical



Mechanical

Seat Adjustment

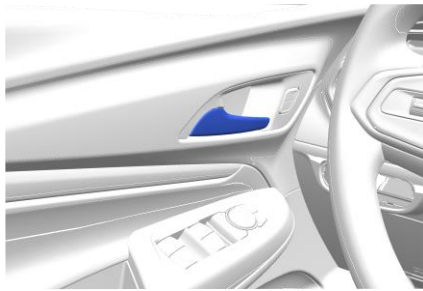

### Opening a Locked Door

If the doors remain locked, pull **twice** on the inside door handle to gain access to the occupant at each seating location.



- The windshield and the roof glass are made of Laminated Glass



- The side door windows and the liftgate window are made of Tempered Glass



## 5. Stored energy / liquids / gases / solids

Li-ion



Coolant leaking inside the battery pack can become unstable and possibly a risk for a fire. Check the battery pack temperature using a thermal imaging camera.

## 6. In case of fire



Potential for Battery Re-Ignition.



A battery on fire will not explode.



Use copious amounts of water to cool the battery to extinguish the fire.

## 7. In case of submersion

All high voltage components and the high voltage battery enclosure are connected to the vehicle chassis ground. If the vehicle is immersed in water, you will not be electrocuted by touching the vehicle.

## 8. Towing / transportation / storage



Front Hook

Rear Hook

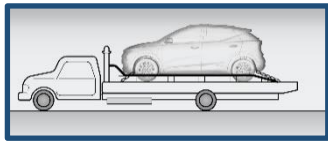

Flatbed towing is the best way to transport the vehicle.

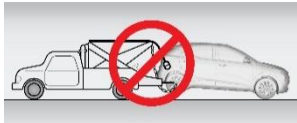
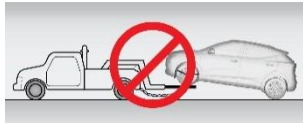

## 9. Important additional information

This vehicle is supported by OnStar, where available.

## 10. Explanation of pictograms used

	Electric Vehicle		Flammable
	General warning sign		Toxic
	Warning, Electricity		Corrosive
	Battery Technology		Injury Risk
	Lifting Points		Use Water
	Thermal Imaging Camera		